

Client \_\_\_\_\_ Quantity \_\_\_\_\_  
 Project \_\_\_\_\_ Position \_\_\_\_\_

## Pastry EN60x40 counter 4 doors

Model: TA21/1BJR-710

Cod: T20412000401

Pastry refrigerated counter 4 doors, counter body height 710 mm, top with splashback. Remote refrigeration unit, 5 heavy duty climatic class and R452a refrigerant gas. Temperature range -15°-22°C with ventilated refrigeration. Equipment: 16 pairs of slides for EN60x40 shelves. Each compartment can be configured with 1/2+1/2, 1/3+2/3, 1/3+1/3+1/3 drawers. Anti-corrosion treated evaporator and electric defrosting. 60 mm insulation thickness - HFO with high insulation performance and low environmental impact (CFC, HCFC, HFC free). AISI 304 stainless steel handle and magnetic triple chamber door gasket, easily replaceable. Reversible, self-closing door opening with 105° stop. AISI 304 stainless steel interior/exterior including external back. Rounded inner corners for easy cleaning. The reinforced modular base in colaminated steel allows installation on wheels, feet, mobile or masonry plinths. Replaceable refrigerant system FSS - Fast Service System - for quick and easy service. Prepared for connection to Cosmo - wi-fi remote supervision system - and ModBus/RTU Rs485 connection.



### Technical data

Top:	With top and splashback
Gross capacity:	825 lt
Temperature range:	-15°-22°C
Refrigerant unit:	remote
Cooling gas:	R452a (GWP=2.141)
Defrost:	Electric
Body height:	710 mm
Valve:	Supplied standard with solenoid
Dimensions:	2350×800×950 mm
Packing dimensions:	2655×900×998 mm
Net / gross weight:	185 Kg / 195 Kg
Net / gross volume:	509 lt / 825 lt
Voltage:	220-240 V - 50-60 Hz
Total rate:	970W - 4,4A
Cooling capacity:	646 W*
*:	Evap. -30°C Cond. +55°C

### Features

Standard equipment:	16 slides EN60x40
Control:	Electronic, display flush with the panel
Doors:	4 doors, self-closing, reversible with 105° stop
Door gasket:	Magnetic, triple chamber and easily replaceable
Insulation:	60 mm thickness - CFC/HCFC free
Exterior/interior finishing:	Exterior interior and back in AISI 304 stainless steel. Base in colaminated steel.
Inner corners:	Rounded for easy cleaning and ensuring maximum hygiene
Handle:	Stainless steel AISI 304, 2 mm thick
Racks and slides:	Stainless steel AISI 304
Feets:	AISI 304 stainless steel adjustable h 100/150 mm
Cosmo:	Predisposed for Cosmo Hub connection

## Accessories and variants

Drawers 1/2	Granite flat worktop
Drawers 1/3	Granite worktop with splashback
Drawers 1/3 + 2/3	Remote condensing unit NT2180GK
Technical compartment on the left	Adjustable feet h 145/195 mm
Common technical compartment	6 Swivel and brake castors h 128 mm
Counters without a technical compartment	Aluminium coated backingan EN60x40 h 20 mm
Lock with key for drawer 1/2	Stainless steel shelf EN60x40
Lock with key for drawer 1/3	Plastic coated shelf EN60x40
Lock with key for drawer 1/3 + 2/3	Pair of type L slides 605 mm
RAL customisable colouring	Serial interface, RS485 cable
Predisposition for connection to CO2 remote control unit	Cosmo cable connection kit
Alimentazione frequenza 60Hz	Cosmo wifi connection kit
Other special voltage	Removable plinth EN 4DR h 100 mm
Internal hygiene H3	Removable plinth EN 4DR h 150 mm

## Remote unit technical data

Voltage:	220-240 V - 50 Hz
Unit total rate :	840W - 3,8A
Cooling gas:	R452A
Gross weight:	30,2 Kg
Dimensions:	500x330x295 mm
Pipe delivery:	Ø 3/8"
Pipe suction:	Ø 3/8"
Packing dimensions:	540x345x310 mm
Cooling capacity:	Evap. -30°C Cond. +55°C

### COSMO - wi-fi control

Cosmo is The Nice Kitchen's exclusive Wi-Fi technology that allows Coldline, Modular and Nevo appliances to be connected and monitored from a smartphone. The counter, connected with Cosmo kit via cable to a Cosmo hub (MODI, VISION, THAW.PRO, LEVTRONIC, QUBI) or with Cosmo Wi-Fi kit, can be monitored by the CosmoApp and receive alerts in case of abnormal operation.

## Technical draw

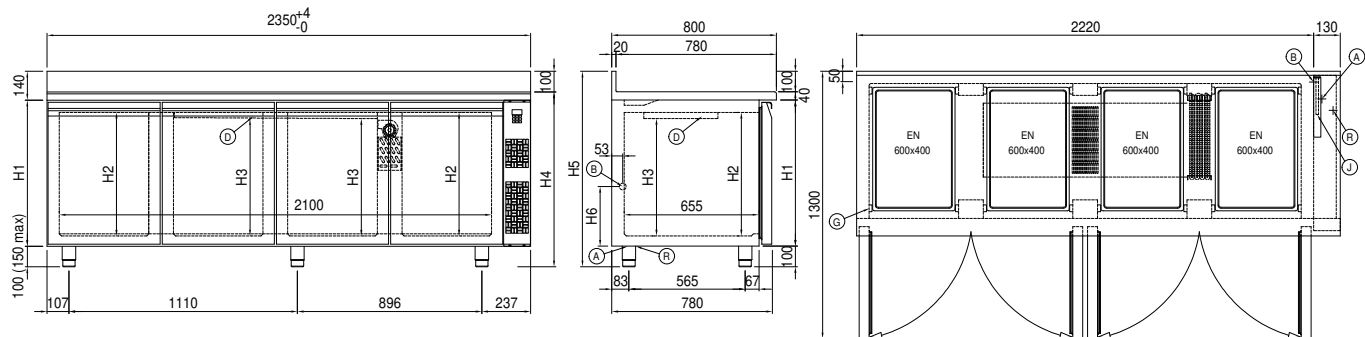

A:	Power supply cable outlet	B:	Condensation water drain	D:	Airflow conveyor
G:	Racks pitch	J:	Automatic evaporation of condensing water	R:	Gas output pipes

In order to constantly offer the best possible products we reserve the right to make changes on technical specifications without incurring any obligation for equipment previously or subsequently sold.