

Client _____ Quantity _____

Project _____ Position _____

Pastry EN60x40 counter 1 door

Model: TP09/1BJR-660

Cod: T20111000403



Technical data

Top:	With top
Gross capacity:	157 lt
Temperature range:	-15°-22°C
Refrigerant unit:	remote
Cooling gas:	R452a
Defrost:	Electric
Body height:	660 mm
Valve:	Supplied standard with solenoid
Dimensions:	755×800×800 mm
Packing dimensions:	990×900×998 mm
Gross weight:	78 Kg
Voltage:	220-240 V - 50-60 Hz
Total rate:	765 W
Absorbed Current:	3,5 A
Cooling capacity:	540 W*

Features

Standard equipment:	4 slides EN60x40
Control:	Electronic, display flush with the panel
Doors:	1 door, self-closing, reversible with 105° stop
Door gasket:	Magnetic, triple chamber and easily replaceable
Insulation:	60 mm thickness - CFC/HCFC free
Exterior/interior finishing:	Exterior interior and back in AISI 304 stainless steel. Base in colaminated steel.
Inner corners:	Rounded for easy cleaning and ensuring maximum hygiene
Handle:	Stainless steel AISI 304, 2 mm thick
Racks and slides:	Stainless steel AISI 304
Feets:	AISI 304 stainless steel adjustable h 100/150 mm
Cosmo:	Predisposed for Cosmo Hub connection

Accessories and variants

Drawers 1/2	Granite flat worktop
Drawers 1/3	Granite worktop with splashback
Drawers 1/3 + 2/3	Remote condensing unit NT2178GK
Technical compartment on the left	Adjustable feet h 145/195 mm
Common technical compartment	4 Swivel and brake castors h 128 mm
Counters without a technical compartment	Aluminium coated backingan EN60x40 h 20 mm
Lock with key for drawer 1/2	Stainless steel shelf EN60x40
Lock with key for drawer 1/3	Plastic coated shelf EN60x40
Lock with key for drawer 1/3 + 2/3	Pair of type L slides 605 mm
RAL customisable colouring	Serial interface, RS485 cable
Predisposition for connection to CO2 remote control unit	Cosmo cable connection kit
Alimentazione frequenza 60Hz	Removable plinth EN 1DR h 50 mm
Other special voltage	Removable plinth EN 1DR h 100 mm
Internal hygiene H3	Removable plinth EN 1DR h 150 mm

Remote unit technical data

Voltage:	220-240V - 50Hz
Cooling gas:	R452A
Gross weight:	25,7 Kg
Dimensions:	500x330x295 mm
Packing dimensions:	540x345x310 mm
Cooling capacity:	Evap. -30°C Cond. +55°C

COSMO - wi-fi control

Cosmo è la tecnologia wi-fi che permette di connettere e monitorare da smartphone gli apparecchi Coldline. Collega i tavoli Pastry ad un Cosmo hub (MODI, VISION o LEVTRONIC) e dall'app potrai controllare le condizioni di funzionamento di ogni macchina e ricevere alert in caso di funzionamento anomalo.

Technical draw

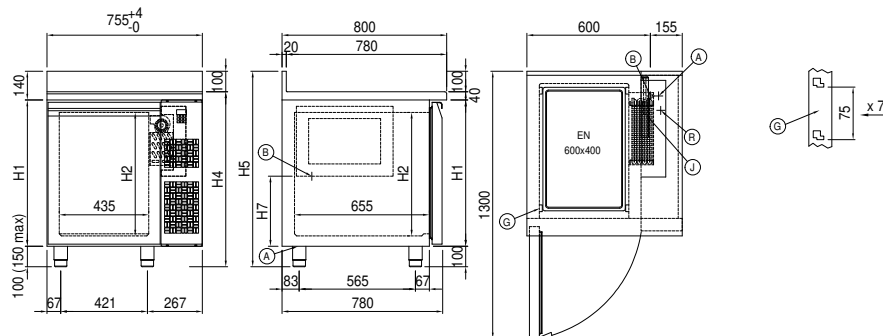

A: Power supply cable outlet	B: Condensation water drain	G: Racks pitch
J: Automatic evaporation of condensing water	R: Gas output pipes	