

Client \_\_\_\_\_ Quantity \_\_\_\_\_  
 Project \_\_\_\_\_ Position \_\_\_\_\_

## Pastry EN60x40 counter 2 doors

**Model:** TA13/1MJ-760

**Cod:** T20202000202

Pastry refrigerated counter 2 doors, counter body height 760 mm, top with splashback. Plug-in refrigeration unit, B energetic class, 5 heavy duty climatic class and R290 ecological refrigerant gas. Temperature range -2°+8°C with ventilated refrigeration. Equipment: 8 pairs of slides for EN60x40 shelves. Each compartment can be configured with 1/2+1/2, 1/3+2/3, 1/3+1/3+1/3 drawers. Anti-corrosion treated evaporator and hot gas defrosting. 60 mm insulation thickness - HFO with high insulation performance and low environmental impact (CFC, HCFC, HFC free). AISI 304 stainless steel handle and magnetic triple chamber door gasket, easily replaceable. Reversible, self-closing door opening with 105° stop. AISI 304 stainless steel interior/exterior including external back. Rounded inner corners for easy cleaning. The reinforced modular base in colaminated steel allows installation on wheels, feet, mobile or masonry plinths. Replaceable refrigerant system FSS - Fast Service System - for quick and easy service. Prepared for connection to Cosmo - wi-fi remote supervision system - and ModBus/RTU Rs485 connection.



### Technical data

<b>Top:</b>	With top and splashback
<b>Gross capacity:</b>	421 lt
<b>Temperature range:</b>	-2°+8°C
<b>Refrigerant unit:</b>	Plug-in
<b>Energetic class:</b>	B
<b>Energy efficiency index:</b>	32,1
<b>Annual consumption:</b>	803 kW/h annum
<b>24h consumption:</b>	2,2 kW/h/24h
<b>Climate class:</b>	5
<b>Cooling gas:</b>	R290
<b>Defrost:</b>	Hot gas
<b>Body height:</b>	760 mm
<b>Valve:</b>	Supplied standard with solenoid
<b>Dimensions:</b>	1450×800×1000 mm
<b>Packing dimensions:</b>	1545×900×998 mm
<b>Gross weight:</b>	156 Kg
<b>Voltage:</b>	220-240 V - 50 Hz
<b>Total rate:</b>	250 W
<b>Absorbed Current:</b>	1,15 A
<b>Cooling capacity:</b>	406 W*
<b>*:</b>	Evap. -10°C Cond. +55°C

### Features

<b>Standard equipment:</b>	8 slides EN60x40
<b>Control:</b>	Electronic, display flush with the panel
<b>Doors:</b>	2 doors, self-closing, reversible with 105° stop
<b>Door gasket:</b>	Magnetic, triple chamber and easily replaceable
<b>Insulation:</b>	60 mm thickness - CFC/HCFC free
<b>Exterior/interior finishing:</b>	Exterior interior and back in AISI 304 stainless steel. Base in colaminated steel.
<b>Inner corners:</b>	Rounded for easy cleaning and ensuring maximum hygiene
<b>Handle:</b>	Stainless steel AISI 304, 2 mm thick
<b>Racks and slides:</b>	Stainless steel AISI 304
<b>Feets:</b>	AISI 304 stainless steel adjustable h 100/150 mm
<b>Cosmo:</b>	Predisposed for Cosmo Hub connection

## Accessories and variants

Drawers 1/2	Granite worktop with splashback
Drawers 1/3	Service water sink Ø 300 mm
Drawers 1/3 + 2/3	Single lever mixer hole Ø 3/4
Technical compartment on the left	Adjustable feet h 145/195 mm
Lock with key for drawer 1/2	4 Swivel and brake castors h 128 mm
Lock with key for drawer 1/3	Aluminium coated backingan EN60x40 h 20 mm
Lock with key for drawer 1/3 + 2/3	Stainless steel shelf EN60x40
RAL customisable colouring	Plastic coated shelf EN60x40
Plug-in water unit	Pair of type L slides 605 mm
Stainless steel evaporator	IP44 schuko socket with cover
Alimentazione frequenza 60Hz	Serial interface, RS485 cable
Other special voltage	Cosmo cable connection kit
Internal hygiene H3	Cosmo wifi connection kit
Granite flat worktop	Removable plinth EN 2D h 100 mm

## COSMO - wi-fi control

Cosmo is The Nice Kitchen's exclusive wi-fi technology that allows Coldline, Modular and Nevo appliances to be connected and monitored from a smartphone. The counter, connected with Cosmo kit via cable to a Cosmo hub (MODI, VISION, THAW.PRO, Levtronic, QUBI) or with Cosmo wi-fi kit, can be monitored by the CosmoApp and receive alerts in case of abnormal operation.

## Technical draw

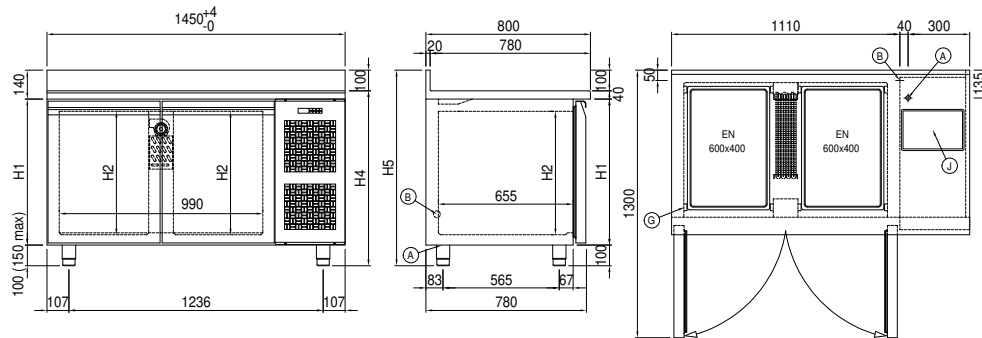

**A:** Power supply cable outlet

**B:** Condensation water drain

**G:** Racks pitch

**J:** Automatic evaporation of condensing water