

Client _____ Quantity _____
 Project _____ Position _____

Prep-station EN60x40 counter 3 doors

Model: TVG17/1MZ-1/3-760

Cod: T20303000222

Prep-Station 800 refrigerated counter 3 doors, counter body height 760 mm, with Rosa Beta granite top. Plug-in refrigeration unit, 5 heavy duty climatic class and R290 ecological refrigerant gas. Temperature range -2°+8°C with ventilated refrigeration. Refrigerated container for GN1/3 bowls with opening lid. Equipment: 3 EN60x40 plastic coated shelves. Each compartment can be configured with 1/2+1/2, 1/3+2/3, 1/3+1/3+1/3 drawers. Anti-corrosion treated evaporator and hot gas defrosting. 60 mm insulation thickness - HFO with high insulation performance and low environmental impact (CFC, HCFC, HFC free). AISI 304 stainless steel handle and magnetic triple chamber door gasket, easily replaceable. Reversible, self-closing door opening with 105° stop. AISI 304 stainless steel interior/exterior including external back. Rounded inner corners for easy cleaning. The reinforced modular base in colaminated steel allows installation on wheels, feet, mobile or masonry plinths. Replaceable refrigerant system FSS - Fast Service System - for quick and easy service. Prepared for connection to Cosmo - wi-fi remote supervision system - and ModBus/RTU Rs485 connection.



Technical data

Top:	With top
Gross capacity:	658 lt
Temperature range:	-2°+8°C
Refrigerant unit:	Plug-in
Cooling gas:	R290
Defrost:	Hot gas
Body height:	760 mm
Valve:	Supplied standard with solenoid
Dimensions:	2005×800×1055 mm
Packing dimensions:	2100×900×998 mm
Gross weight:	214 Kg
Voltage:	220-240 V - 50 Hz
Total rate:	250 W
Absorbed Current:	1,15 A
Cooling capacity:	406 W*
*:	Evap. -10°C Cond. +55°C

Features

Standard equipment:	3 slides, 3 plastic coated EN60x40 shelves
Control:	Electronic, display flush with the panel
Doors:	3 doors, self-closing, reversible with 105° stop
Door gasket:	Magnetic, triple chamber and easily replaceable
Insulation:	60 mm thickness - CFC/HCFC free
Exterior/interior finishing:	Exterior interior and back in AISI 304 stainless steel. Base in colaminated steel.
Inner corners:	Rounded for easy cleaning and ensuring maximum hygiene
Lid hinges:	Made of black plastic
Handle:	Stainless steel AISI 304, 2 mm thick
Racks and slides:	Stainless steel AISI 304
Feets:	AISI 304 stainless steel adjustable h 100/150 mm
Cosmo:	Predisposed for Cosmo Hub connection

Accessories and variants

Drawers 1/2	Adjustable feet h 145/195 mm
Drawers 1/3	4 Swivel and brake castors h 128 mm
Drawers 1/3 + 2/3	EN drawer reduction kit for GN containers
Special counter body heights 700 mm	Brackets for GN pans for drawer
Special counter body heights 750 mm	GN1/2 container + lids kit for drawer, h 150 mm
Technical compartment on the left	GN1/3 container + lids kit for drawer, h 150 mm
Special size of technical compartment	Stainless steel shelf EN60x40
Lock with key for drawer 1/2	Plastic coated shelf EN60x40
Lock with key for drawer 1/3	Pair of type L slides 605 mm
Lock with key for drawer 1/3 + 2/3	Serial interface, RS485 cable
LED lighting	Cosmo cable connection kit
RAL customisable colouring	Cosmo wifi connection kit
Plug-in water unit	IP44 schuko socket with cover
Alimentazione frequenza 60Hz	Prep-Station pans kit GN1/3 plug-in, 3D EN
Other special voltage	Removable plinth EN 3D h 100 mm

COSMO - wi-fi control

Cosmo is The Nice Kitchen's exclusive wi-fi technology that allows Coldline, Modular and Nevo appliances to be connected and monitored from a smartphone. The counter, connected with Cosmo kit via cable to a Cosmo hub (MODI, VISION, THAW.PRO, Levtronic, QUBI) or with Cosmo wi-fi kit, can be monitored by the CosmoApp and receive alerts in case of abnormal operation.

Technical draw

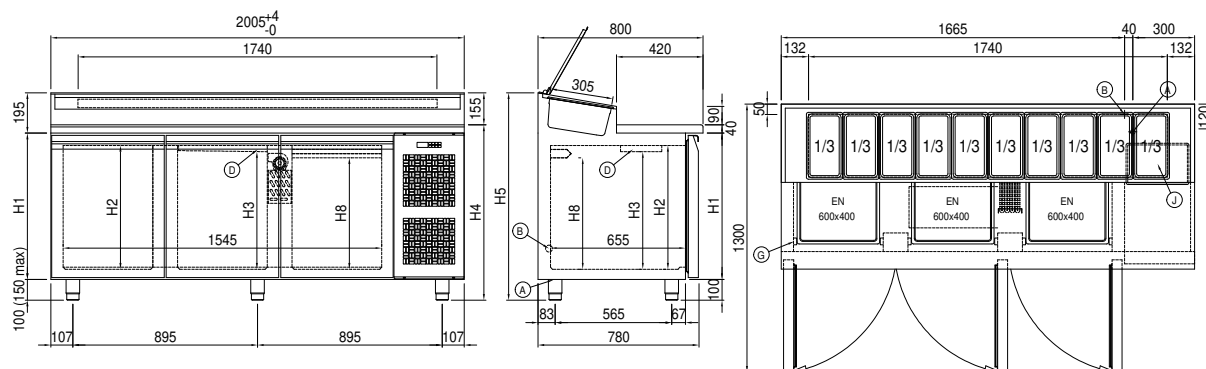

A: Power supply cable outlet	B: Condensation water drain	D: Airflow conveyor
G: Racks pitch	J: Automatic evaporation of condensing water	R: Gas output pipes